



Robotic Vacuum Cleaner User Manual

- * Before operating this unit, please read the instructions carefully.
- * For indoor use only.

English

imagine the possibilities

Thank you for purchasing a Samsung product.
To receive a more complete service,
please register your product at
www.samsung.com/register

SAMSUNG

Safety information

SAFETY INFORMATION





- Before operating the appliance, please read this manual thoroughly and retain it for your reference.



- Because these following operating instructions cover various models, the characteristics of your vacuum cleaner may differ slightly from those described in this manual.

CAUTION/WARNING SYMBOLS USED

	Indicates that a danger of death or serious injury exists.
	Indicates that a risk of personal injury or material damage exists.

OTHER SYMBOLS USED

	Explains terms to help users understand how use the product properly.
---	---

Safety information

IMPORTANT SAFETY INSTRUCTIONS

When using an electrical appliance, basic precautions should be observed, including the following:

READ ALL INSTRUCTIONS BEFORE USING YOUR ROBOTIC VACUUM CLEANER.

Unplug from outlet when not in use and before conducting maintenance.

WARNING: to reduce the risk of fire, electric shock, or injury:

GENERAL

- Use only as described in this manual.
- Do not operate the robotic vacuum cleaner or charger if it has been damaged in any way.
- If the cleaner is not working as it should, has been dropped, damaged, left outdoors, or dropped in water, return it to a customer care center.
- Do not handle the charger or robotic vacuum cleaner with wet hands.
- Use only on dry, indoor surfaces.
- This appliance is not intended for use by persons (including children) with reduced physical, sensory or mental capabilities, or lack of experience and knowledge, unless they have been given supervision or instruction concerning use of the appliance by a person responsible for their safety.
- Children should be supervised to ensure that they do not play with the appliance.

BATTERY CHARGER

- Do not modify the polarized plug to fit a non-polarized outlet or extension cord.
- Do not use outdoors or on wet surfaces.
- Unplug the charger from the outlet when not in use and before servicing.
- Use only the charger supplied by the manufacturer to recharge.
- Do not use with a damaged cord or plug.
- Do not pull or carry by the cord, use the cord as a handle, close the door on the cord, or pull the cord around sharp edges or corners. Keep the cord away from heated surfaces.
- Do not use extension cords or outlets with inadequate current carrying capacity.
- Do not unplug by pulling on the cord. To unplug, grasp the plug, not the cord.
- Do not mutilate or incinerate batteries as they will explode at high temperatures.
- Do not attempt to open the charger. Repairs should only be carried out by a qualified customer care centre.
- Do not expose the charger to high temperatures or allow moisture or humidity of any kind to come into contact with the charger.

Safety information

ROBOTIC VACUUM CLEANER

- Do not pick up hard or sharp objects such as glass, nails, screws, coins, and etc.
- Do not use without a filter in place. When servicing the unit, never put fingers or other objects into the fan chamber in case the unit accidentally turns on.
- Do not put any objects into openings. Do not use with any openings blocked; keep openings free of dust, lint, hair, and anything that may reduce air flow.
- Do not pick up toxic materials (chlorine bleach, ammonia, drain cleaner, etc.).
- Do not pick up anything that is burning or smoking, such as cigarettes, matches, or hot ashes.
- Do not use to pick up flammable or combustible liquids such as gasoline, nor use on areas where they may be present.
- Do not use robotic vacuum cleaner in an enclosed space filled with vapours given off by oil based paint, paint thinner, moth proofing substances, flammable dust, or other explosive or toxic vapours.
- Leaks from battery cells can occur under extreme usage or temperature conditions. If the liquid gets on skin, wash quickly with water. If the liquid gets into the eyes, flush them immediately with clean water for a minimum of 10 minutes. Seek medical attention.

Save these instructions!

This vacuum cleaner is intended for household use only.

FOR RESIDENTS OF THE UNITED KINGDOM ONLY

If your appliance is fitted with a nonrewireable BS 1363 plug it must not be used unless a 13 amp (ASTA approved to BS 1362) fuse is fitted in the carrier contained in the plug. If for any reason the plug is cut off, it must be disposed of, as it is an electric shock hazard should it be inserted into a 13 amp socket.

Contents

SAFETY INFORMATION	06	Power related
	07	Before use
	10	In use
	11	Cleaning and maintenance
	02	
PRODUCT FEATURES	13	Product Features
	13	
ASSEMBLING THE CLEANER	15	Components
	16	Name of each part
	15	
OPERATING THE CLEANER	20	Installing robotic vacuum cleaner
	20	Installation order
	20	Turning the power switch on or off
	21	Installing the charger
	22	Charging
	23	About the battery
	24	Installing the VIRTUAL GUARD
	26	Using robotic vacuum cleaner
	26	Starting/stopping cleaning
	27	Recharging
	28	Auto cleaning
	29	Spot cleaning
	30	Max cleaning
	31	Manual cleaning
	32	Edge Cleaning
	33	Scheduled Cleaning
MAINTAIN TOOLS AND FILTER	34	Cleaning robotic vacuum cleaner
	34	Please keep the cleaning and maintenance methods in mind
	34	Cleaning the sensor window and the camera
	35	Cleaning the dust bin and the Filter
	36	Cleaning the power brush
	38	Cleaning the edge-cleaning side rotating brush
	39	Cleaning the driving wheel
	34	
TROUBLESHOOTING	40	Checklist before svc calls
	42	Troubleshooting for Error Codes
	40	
PRODUCT SPECIFICATION	43	Product specification
	43	

Safety information

POWER RELATED



Do not bend the power cord forcefully or place a heavy object on it that could break it.

- This may result in fire or electric shock.

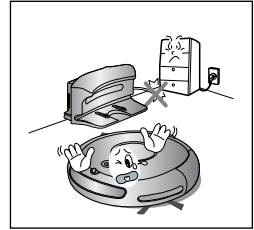

Make sure to remove any dust or water from the power plug.

- Failing to do so may result in a malfunction or electric shock.

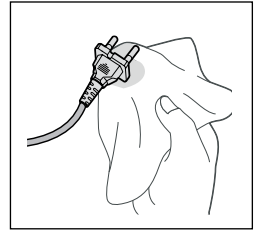

Do not pull the power plug by the cord or touch the plug with wet hands.

- This may result in fire or electric shock.

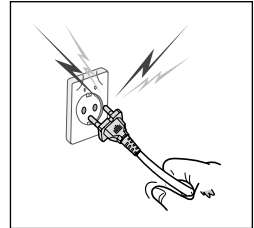

Do not use multiple plugs in a single socket. (Do not leave the cord lying exposed on the floor.)

- This may result in fire or electric shock.

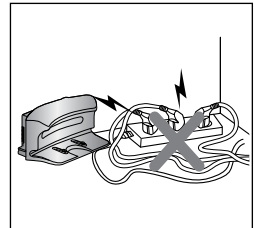

Do not use a damaged power cord, plug, or a loose power outlet.

- This may result in fire or electric shock.

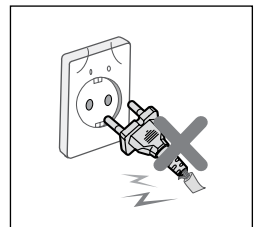

Safety information

BEFORE USE



Before activating the robotic vacuum cleaner, make sure that the dust bin is assembled.

- If the dust bin is not inserted, robotic vacuum cleaner will not operate.

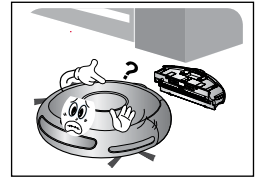

Never use robotic vacuum cleaner in locations with combustible material such as:

- Locations with candles or desk lamps on the floor.
- Locations with unattended fires (fire or embers).
- Locations with gasoline, distilled alcohol, thinner, ashtrays with burning cigarettes, etc.

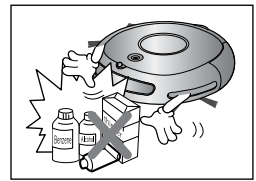

Robotic vacuum cleaner is for domestic use only. Do not use it in the following locations.

- Attics, basements, warehouses, industrial buildings, separate rooms distant from the main building, locations exposed to wet or damp conditions such as bathrooms or wash rooms, and narrow and highly situated locations such as tables or shelves. Critical damage (abnormal operation and breakage) may occur when used in these locations.



Open all doors to clean all rooms.

- When a door is closed, the robotic vacuum cleaner will not be able to enter that room.
- However, make sure to close the doors to the main entrance, the veranda and the bathroom, and any other rooms where the robotic vacuum cleaner may fall to a lower floor.



For carpets with long tassels, fold the tassels under the carpet.

- Unfolded tassels may result in critical damage to the carpet and the machine itself, as they get caught in the driving wheel or the power brush.

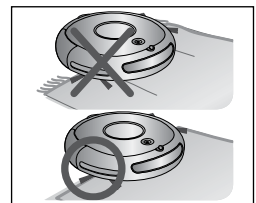

When the cliff sensor is polluted, the robotic vacuum cleaner may be in danger of falling down the stairs.

This may cause personal injury and critical damage to the product.
To prevent risk, install the VIRTUAL GUARDS (Fence Mode setting) in front of dangerous areas. Clean the sensor window and camera.

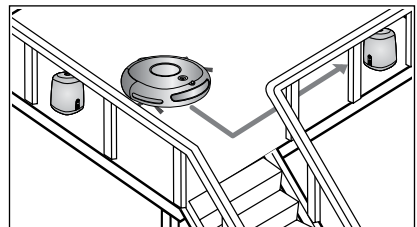

Safety information

BEFORE USE



Remove small objects or brittle items from the area to be cleaned in advance.

- Make sure to clear any objects before cleaning.
- Make sure to remove fragile items such as china, glass objects, flowerpots, etc.
- Robotic vacuum cleaner does not recognize coins, rings or other valuable items such as jewelry.

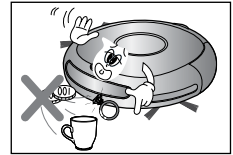

Remove objects scattered on the floor before cleaning.

- Robotic vacuum cleaner is designed to detect obstacles 5cm away from it.
- Bath towels, pads in front of bathrooms and sinks, entrances, utility rooms, power cords, table cloths or belts can become entangled in the driving wheel or power brush. This can cause objects to fall from the table.

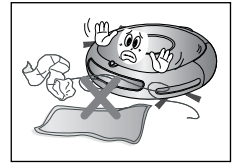

Inform all family members (or relevant parties) to be cautious before cleaning or when using the Scheduled Cleaning Mode.

- Robotic vacuum cleaner may run into children, causing them to fall.



Ensure that children do not step or sit on the robotic vacuum.

- Children may fall and injure themselves or critical damage may occur to the product.



When a child or pet is left alone, make sure to turn off the Power Switch of the robotic vacuum cleaner.

- Robotic vacuum cleaner may attract their attention.
- When the rotating wheel or brush catches fingers, feet, clothing or hair, this may result in injury.
- If a child or pet is in the way of the robotic vacuum cleaner, it may be identified as an obstacle and the area may not be cleaned.
- When the Power Switch is turned off, it will cut off the power supply and deactivate all functions.

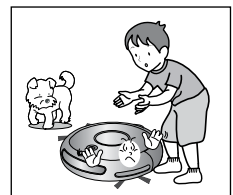

When installing the charger station, do not leave the power cord exposed on the floor.

- When the robotic vacuum cleaner automatically recharges or passes by the charger station, it may drag the power cord around with it.

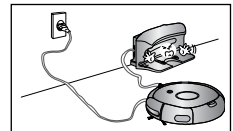

Always keep the power cord of the charger plugged into the outlet.

- Although the robotic vacuum cleaner has a self-charging function, if the power cord of the charger station is unplugged, it cannot charge its battery automatically.

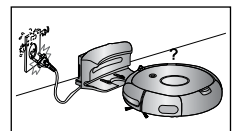

Safety information

BEFORE USE



Install the charger in a location that can be easily accessed by the robotic vacuum cleaner.

- If the charger is installed in a corner, this may cause extra movements and may disturb the automatic recharging process.

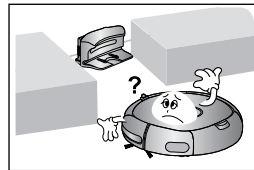

Objects in front of the charger will prevent the robotic vacuum cleaner from auto-charging itself.

- Clear the area.

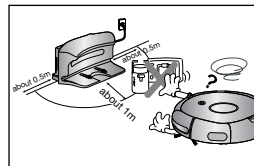

There should be no obstacles 0.5 m to the left and right and within 1 m of the front.

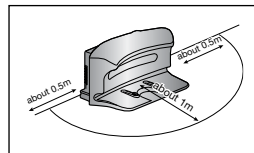

Do not short-circuit the charge pins with metal objects such as chopsticks, screwdrivers, and etc.

- This will result in critical damage to the charger.

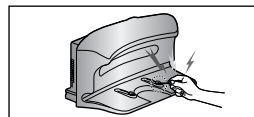

Make sure that there is no trace of liquids on the charger station.

- Failing to do so may result in fire or electric shock.

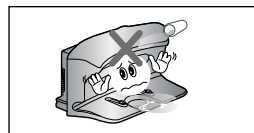

Make sure the robotic vacuum cleaner does not vacuum or move over liquids such as water, oil or pet litter.

- This may result in critical damage to the product.
- Liquids may spread through the wheels resulting in contamination.

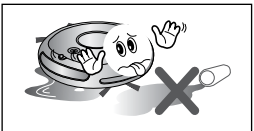

Do not use the charger for other purposes.

- This may result in critical damage to the charger or cause a fire.

Safety information

IN USE



You cannot use the robotic vacuum cleaner on thick carpets.

- This may result in problems with the robotic vacuum cleaner.
- This may result in damage to carpets.

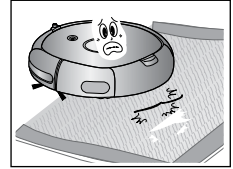

Do not use the robotic vacuum cleaner on a table or other high locations.

- This may result in damage when the unit accidentally drops.



Robotic vacuum cleaner may bump into furniture such as chair legs, table legs, thin and long furniture, etc. while operating.

- For a quicker and cleaner performance, place the chairs on top of the table.

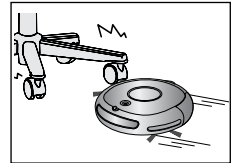

Do not place any objects on top of the robotic vacuum cleaner.

- This may result in malfunction.

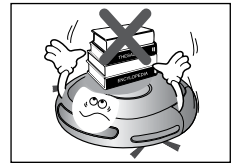

Immediately remove any large pieces of paper or plastic bags from the machine while cleaning.

- Using the machine for an extended period of time with its inlet port obstructed may result in critical damage to the product.



If an unusual sound, smell or smoke is emitted from the robotic vacuum cleaner, immediately turn off the Power Switch and call the customer care center.

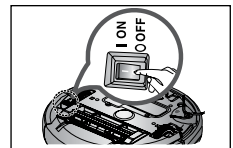

Robotic vacuum cleaner may not be able to continue its operation if it is stuck at the entrance or veranda doorsill.

- Robotic vacuum cleaner stops operating for safety reasons if it cannot move for more than 5 minutes.
- To resume operating, turn the Power Switch off and then on again after moving it to a location where it can continue cleaning.

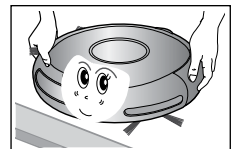

Safety information

IN USE



Robotic vacuum cleaner cannot completely clean locations that it cannot reach, such as corners, and spaces between sofas and walls.

- Please clean these locations occasionally.

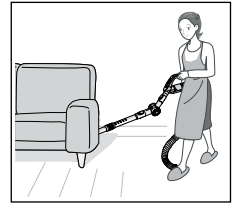

Dust clusters may remain after cleaning, when the robotic vacuum cleaner fails to pick up dust clusters that were formed while cleaning.

- In this case, sweep up the dust with another cleaning tool.

CLEANING AND MAINTENANCE



When cleaning the product, do not spray water directly onto the exterior or wipe it with a volatile material such as benzene, thinner or alcohol.

- This may result in critical damage to the product.



Do not forcefully press the bumper on the robotic vacuum cleaner.

- If the bumper sensor gets damaged, the robotic vacuum cleaner may bump into walls or furniture.

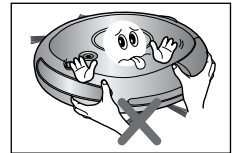

The unit must not be disassembled or reconstructed by anyone other than a qualified service engineer.

- This may result in damage to the product.

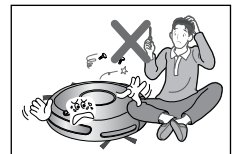

Remove any foreign substances accumulated on the Obstacle and Cliff sensors on a regular basis.

- Dirt accumulated on the sensors will result in inaccurate functioning of the sensors.

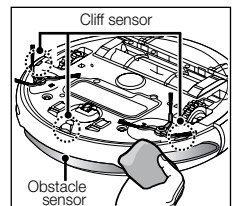

Safety information

CLEANING AND MAINTENANCE



When removing foreign substances, always use the cleaning brush after turning the Power Switch off.

- Failing to do so may result in sudden operation of the unit and cause an injury or critical damage to the product.

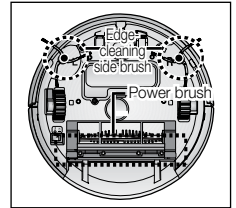

If the power cord is damaged, have it replaced by a qualified service engineer from the customer care center.

- Failing to do so may result in fire or electric shock.



Before cleaning the charger, make sure to disconnect the power cord for safety.



Contact the Samsung Electronics customer care center to replace the battery.

- Failing to use original batteries will result in product failure.

* Battery information :

AA Size Ni-MH, UNION SUPPO, Model HPY, 12 (EA).

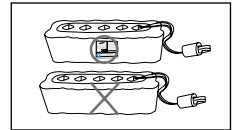

Product Features

CONVENIENT VIRTUAL GUARD FUNCTION

You can confine the robotic vacuum cleaner to a particular section by using the Fence (virtual wall) mode or by cleaning several sections one by one using the Guard (virtual door) mode.

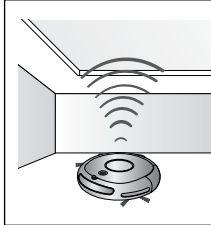
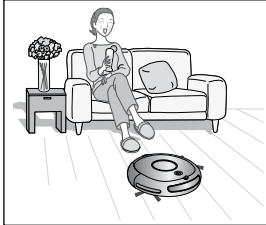

• What is ceiling shape recognition (Visionary mapping™)?

This function recognizes the shape of the ceiling using the camera on top to identify the area to be cleaned and determines the best way to pass over and clean every section of the floor.

DELICATE CLEANING OF EVERY CORNER

Since the robotic vacuum cleaner cleans the floor in a sequential way (🔄) along the map determined by the ceiling shape recognition function, it cleans every corner of the floor.

VARIOUS CLEANING MODES

Various cleaning modes are provided to meet all your needs.

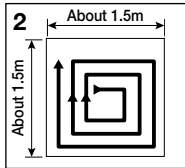
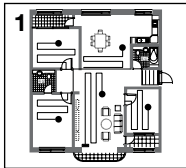

1. Auto Mode

Cleans all rooms automatically.

2. Spot Mode

Cleans a localized area intensely. It can be used to clean bread or cookie crumbs.

3. Max Mode

Runs until the battery is nearly depleted.

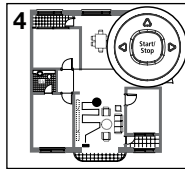
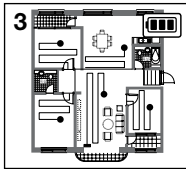

4. Manual Mode

You can clean the floor manually by moving the robotic vacuum cleaner with a remote control.

5. Edge Mode

When the Obstacle Sensor detects an obstacle during the cleaning, the Robot Cleaner reduces its speed to minimize the bumping impact and the Bumper Sensor also helps it lower the bumping impact. And, it cleans the corners by reaching to them as close as possible.

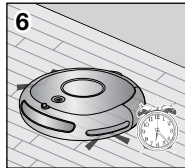
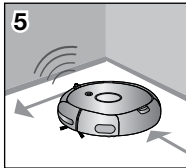

6. Scheduled Cleaning Mode

At the specified time, the robotic vacuum cleaner cleans the floor.

Product Features

AUTO CHARGING

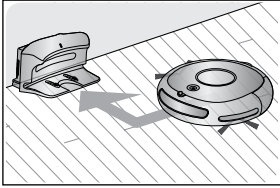

When the battery is low, the robotic vacuum cleaner is automatically guided to the charger to enable it to perform a quick auto charge.

EDGE-CLEANING SIDE ROTATING BRUSH

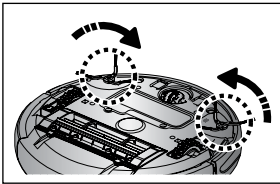

The edge-cleaning side rotating brush cleans dust from the edges.

DOORSILL CROSSING

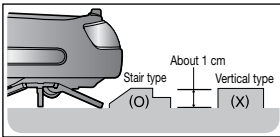

The robotic vacuum cleaner's innovative driving system makes it possible for it to cross over doorsills with a height of about 1 cm and clean all rooms. The robotic vacuum cleaner has been designed so that it does not cross over doorsills that are higher than 1 cm for safety purposes.

ANTI-CRASH

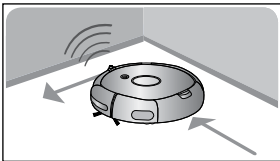

The robotic vacuum cleaner detects and avoids obstacles in 2 stages. First, the 7 obstacle sensors detect obstacles in stage 1 and if the robotic vacuum cleaner does crash into an obstacle, the 2 bumper sensors absorb the impact.

SAFETY DEVICE

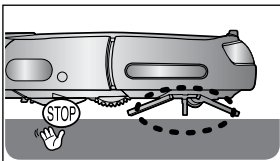

When the robotic vacuum cleaner is lifted up while cleaning, the driving wheels, power brush, suction motor, and side rotating brush are stopped automatically by sensor.

Assembling the cleaner

COMPONENTS

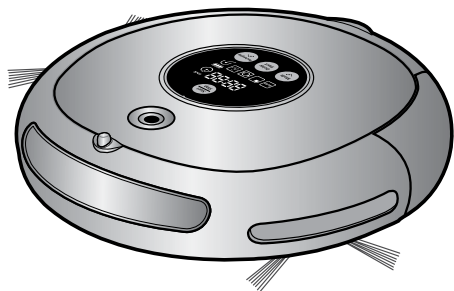

■ Main Body

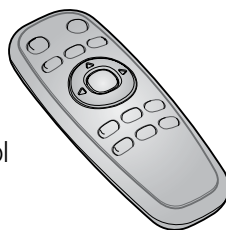

■ Remote Control

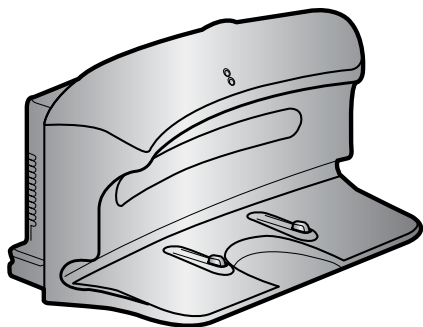

■ Charger (Station)

■ Others Components

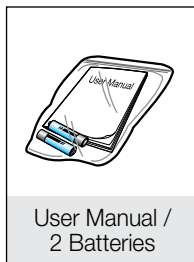

User Manual /
2 Batteries

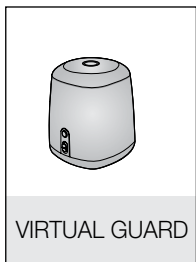

VIRTUAL GUARD

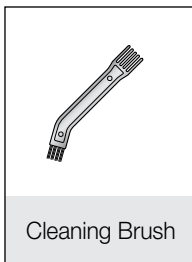

Cleaning Brush

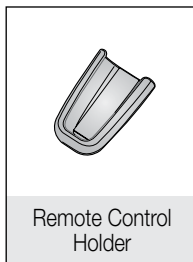

Remote Control
Holder

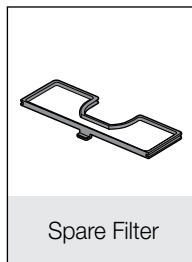

Spare Filter

Assembling the cleaner

NAME OF EACH PART

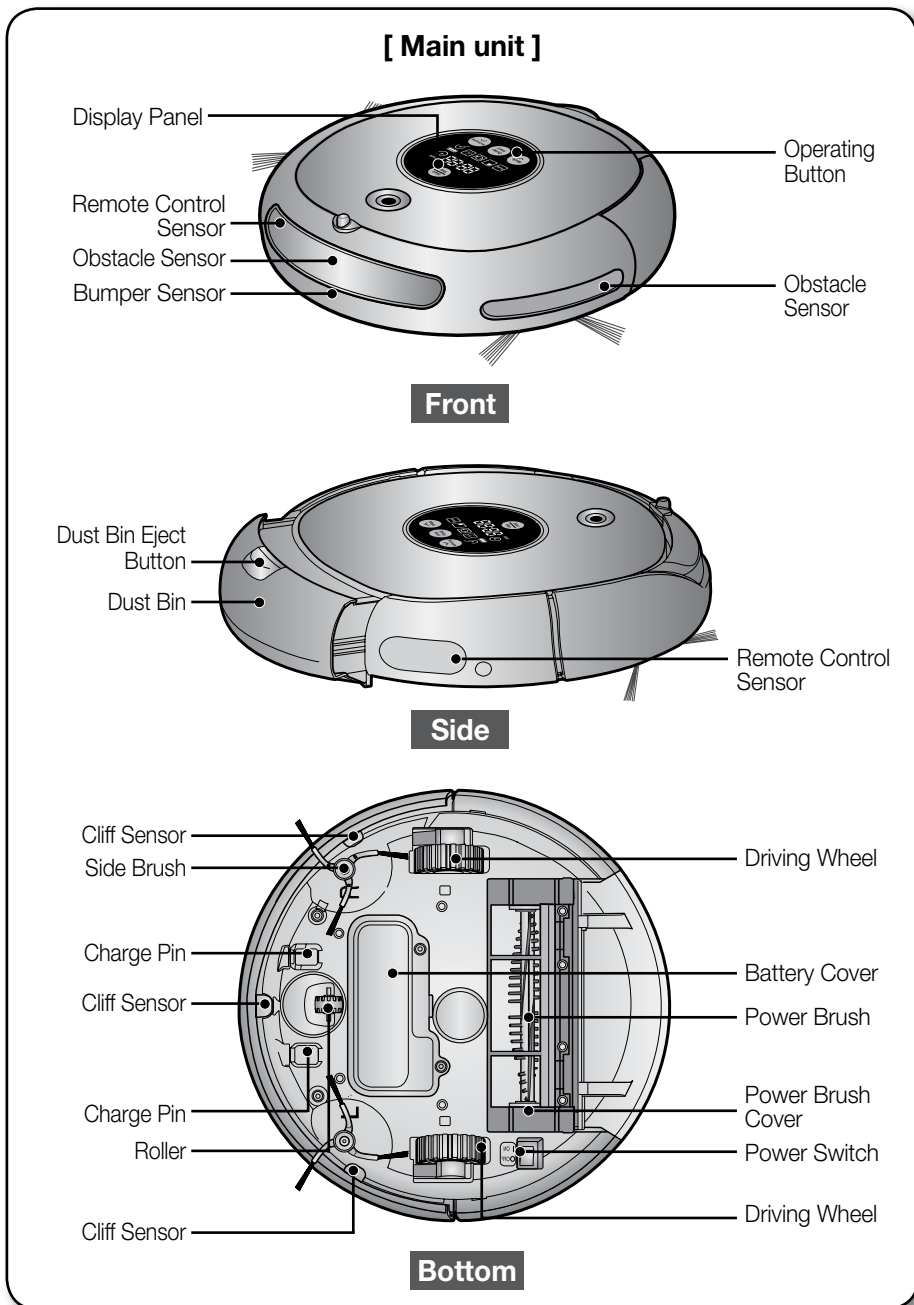

Assembling the cleaner

NAME OF EACH PART

[Charger (Station)]

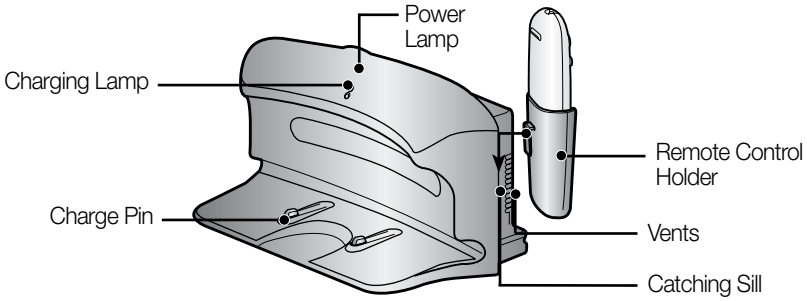

[VIRTUAL GUARD]

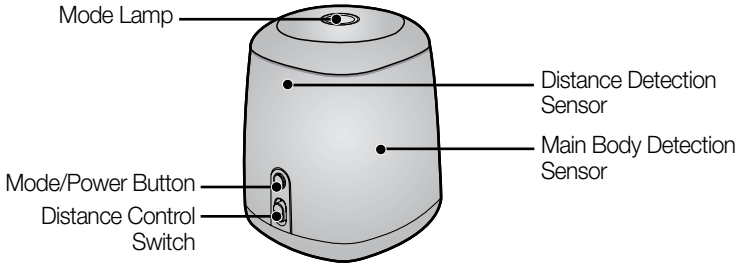

■ Installing the batteries

Batteries are not supplied with the product. You have to purchase the batteries separately. Install the alkaline batteries (type D) before use.

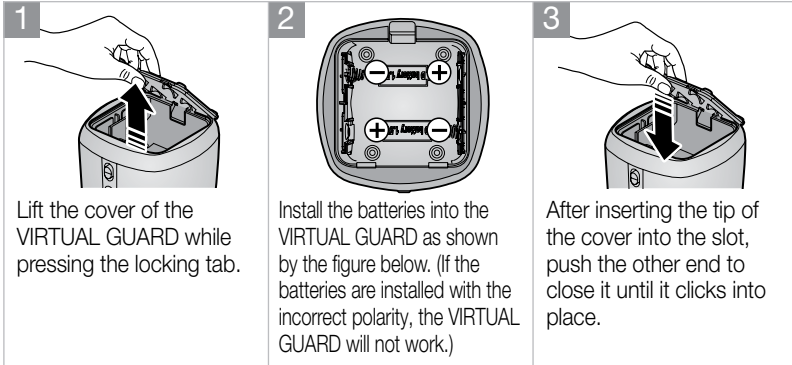

* Specification: Alkaline Type D (LR20) batteries

Assembling the cleaner

NAME OF EACH PART

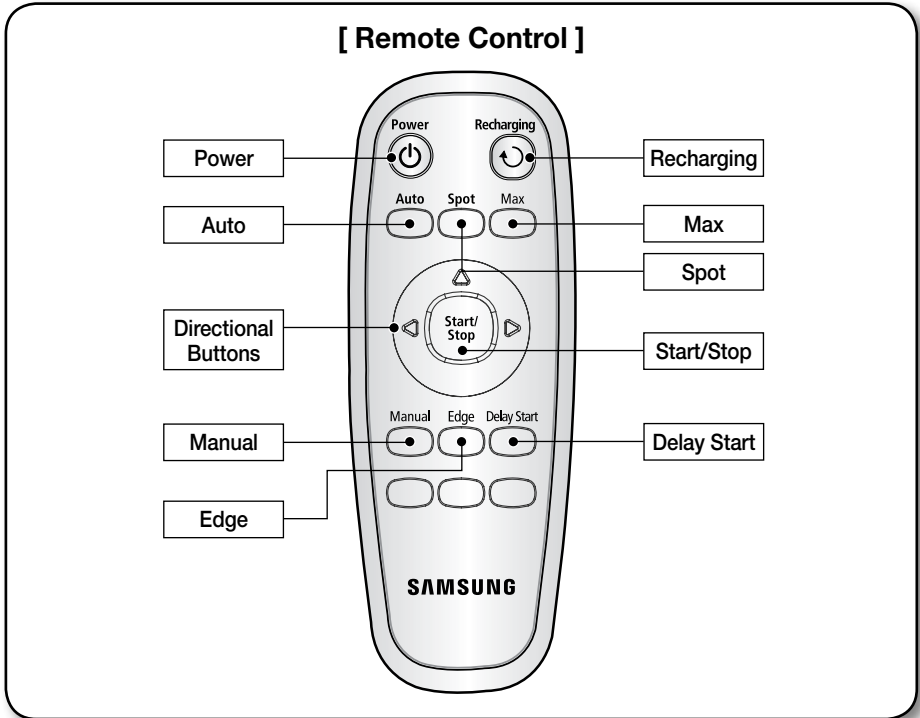

■ Installing the Remote Control Batterise

Batteries are not installed in the remote control when purchasing the product. Install the alkaline batteries (type AAA) before use.

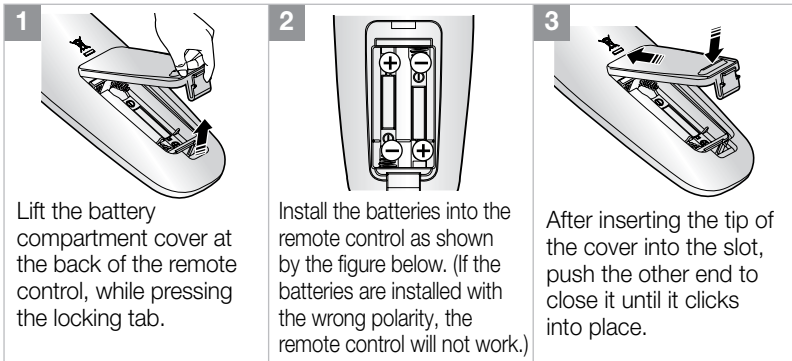

* Specification: Alkaline type AAA batteries

Assembling the cleaner

NAME OF EACH PART

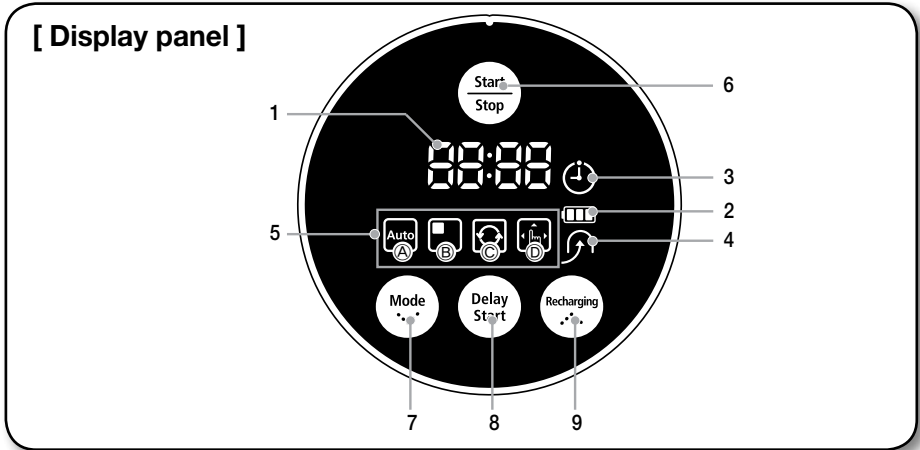

DISPLAY PART

1. Number Display

- Shows the timer display, progress status, and error codes using numbers, letters and graphics.

2. Battery Level Indicator

- Charging: Shows the charging progress in 3 steps.
- In Use: Shows the battery charge level. The battery charge level is reduced by each level from FULL while operating. (When the battery is fully discharged, one level will flash to display "LO".)

3. Scheduled Cleaning

- When cleaning is scheduled, the Scheduled Cleaning icon is lit.

4. Recharging

- This icon turns on when the robotic vacuum cleaner returns to the charger station to charge its battery.

5. Cleaning Mode Display

- Each time the cleaning mode button is pressed, the corresponding cleaning mode is displayed.
 - (a) Auto Mode: This icon turns on when Auto cleaning mode is selected.
 - (b) Spot Mode: This icon turns on when Spot cleaning mode is selected.
 - (c) Max Mode: This icon turns on when Max cleaning mode is selected.
 - (d) Manual Mode: This icon turns on when Manual cleaning mode is selected.
 - (e) Edge Mode : "ㄷ ㄷ" is on when Edge cleaning mode is selected.

BUTTON PART

6. Start/Stop

- Press to start/stop cleaning.

7. Cleaning Mode

- Press to select a cleaning mode. After selecting a cleaning mode, press the () button to start cleaning.

8. Delay Start

- Press to schedule a cleaning. You can delay a cleaning up to 23 hours.

9. Recharging

- When this button is pressed, the Recharging icon is turned on and robotic vacuum cleaner will return to the charger station to charge its battery.

Operating the cleaner

INSTALLING THE ROBOTIC VACUUM CLEANER

INSTALLATION ORDER

1. Turning the Power Switch on or off

To use the robotic vacuum cleaner, you must turn on the Power Switch at the bottom of the main unit.

2. Installing the Charger

To charge the robotic vacuum cleaner, you must first install the charger.

Since the battery is discharged when the product is purchased, you must fully charge the battery before use.

3. Charging the Battery

You should charge the battery completely before using the robotic vacuum cleaner.

4. Installing the VIRTUAL GUARD

You can confine the robotic vacuum cleaner to a particular section by using Fence (virtual wall) mode or clean several sections one by one using Guard (virtual door) mode.



TURNING THE POWER SWITCH ON OR OFF

To use the robotic vacuum cleaner, you must turn the Power Switch on.

If you turn the Power Switch off, all settings will be reset.

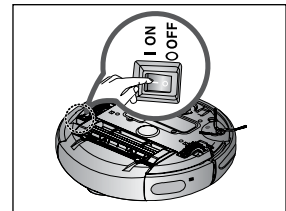

1. Turn over the main unit and turn the Power Switch on.

- If the icons are not turned on, it indicates that the battery charge is depleted. In this case, dock the robotic vacuum cleaner to the charger station after turning the Power Switch on.
- Note that turning the Power Switch off will reset all settings.

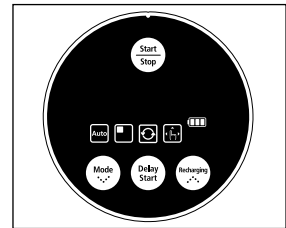

If the Power Switch is turned off, the robotic vacuum cleaner will not be charged even if it is docked with the charger station.

Operating the cleaner

INSTALLING THE ROBOTIC VACUUM CLEANER

INSTALLING THE CHARGER

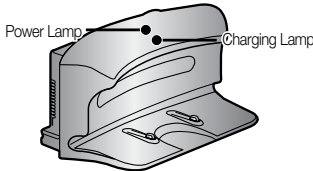

1. Install the charger on a flat surface.

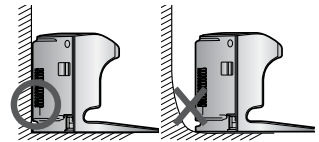

2. There should be no obstacles 0.5 m to the left and right and within 1 m of the front.

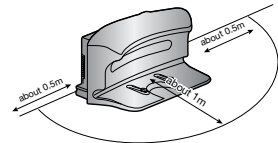

3. Install the charger in a location where it can be easily accessed by the robotic vacuum cleaner.



4. Arrange the power cord along the wall.

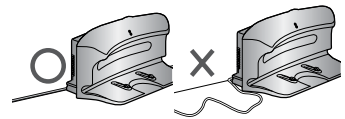

5. When the floor is made of wood, install the charger in the same direction as the grain of the wood.

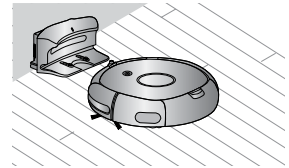

Always keep the power cord of the charger plugged into the power outlet.

- If no power is supplied to the charger, the robotic vacuum will not be able to find the charger and will not be able to charge automatically.
- If the robotic vacuum cleaner is separated from the charger, the battery is automatically discharged.

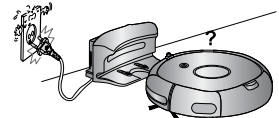

Operating the cleaner

INSTALLING THE ROBOTIC VACUUM CLEANER

CHARGING

When the product is initially purchased, the battery is fully discharged, and you must charge the robotic vacuum cleaner manually.

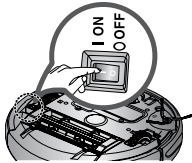

Turn on the Power Switch at the bottom of the product.

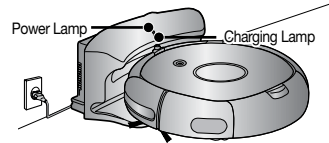

- 1. After aligning the charge pins of the main unit with the charge pin of the charger station, press the main unit until you hear a “Recharging power” sound from the charger.**

- The Charging Lamp turns green.

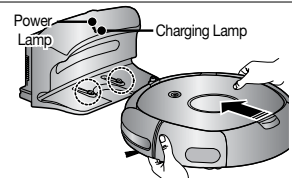

- 2. Check the charge status of the robotic vacuum cleaner.**

- When charging starts, the battery level indicator and “” will be displayed in sequence in the display panel.
- When charging is complete, the battery level indicator and “FULL” will be displayed in the display panel.

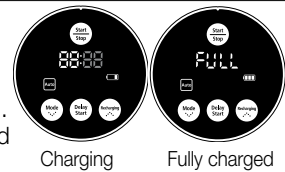

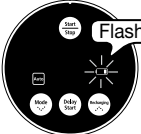

Flash

- When the battery level display flashes while cleaning, the robotic vacuum cleaner stops vacuuming and automatically charges itself at the charger.

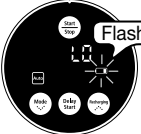

Flash

- When the battery level flashes and “LO” is displayed while cleaning, robotic vacuum cleaner cannot be operated by the remote control or the buttons on the main unit. In this case, directly carry the robotic vacuum cleaner to the charger to charge the battery. (This is when the battery is completely discharged.)

<Charge display>

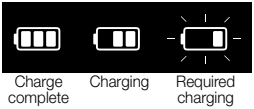

Charge complete Charging Required charging



- When the product is initially purchased, it will take about 120 minutes to fully charge the battery and will run for about 90 minutes.
- When charging the battery while the battery is over-heated, the charging time can increase.
- Measures to take when charging is not smooth.
 - When the robotic vacuum cleaner cannot be automatically charged, check the following:
 - Turn the Power Switch at the bottom of the robotic vacuum cleaner off and on (Reset).
 - Re-plug the power of the charger (Reset).
 - Check whether there are any foreign substances on the charge connector and wipe the charge connector on the main unit and the charger with a dry cloth.
 - Check whether there are objects near the charger that are strong reflectors.
- When separating the robotic vacuum cleaner from the charger, it will discharge naturally.
 - Charge the robotic vacuum cleaner through the charger, if possible. (When leaving your home unattended for a long period of time due to a business trip, travelling etc., turn off the Power Switch of the robotic vacuum cleaner and unplug the power of the charger to store them.)

Operating the cleaner

INSTALLING THE ROBOTIC VACUUM CLEANER

ABOUT THE BATTERY

- The robotic vacuum cleaner is powered by an environment-friendly Nickel Metal Hydride (NiMH) rechargeable battery, and an over-charge prevention function guarantees an extended life time.
- **The battery warranty period is 6 months from the date of purchase.**
- When purchasing a battery, ask the customer care center for the genuine part symbol () and model number before purchasing it.
- * Battery information :
AA Size Ni-MH, UNION SUPPO, Model HPY, 12 (EA).

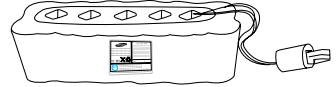

- This battery is only for Samsung robotic vacuums. It is strictly prohibited to use it for other appliances or for other purposes.
 - Do not disassemble or modify the battery.
 - Charge it in a location with good ventilation.
 - Do not expose the battery to fire and do not heat it.
 - Do not connect any metallic objects to the (+) or (-) terminals of the battery.
 - Keep it indoors (0°C~40°C).
 - Before you discard this product, dispose of batteries in an environmentally safe manner.
 - Do not discard batteries with your regular household trash.
 - Follow all local regulations when disposing of old batteries.
- * If the battery is out of order, do not disassemble it. Contact your nearest customer care center.
- * An increased charging time and a shorter battery life indicates the near end of the battery life. Please contact an authorized customer care center to replace your battery.

The rechargeable battery incorporated in this product is not user replaceable. For information on its replacement, please contact your service provider.

Operating the cleaner

INSTALLING THE ROBOTIC VACUUM CLEANER

INSTALLING THE VIRTUAL GUARD

You can confine the robotic vacuum cleaner to a particular section by using Fence (virtual wall) mode or clean several sections one by one using Guard (virtual door) mode.

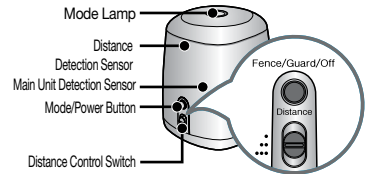

Fence/Guard/Off

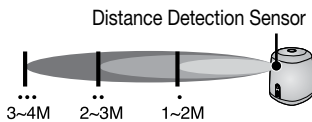
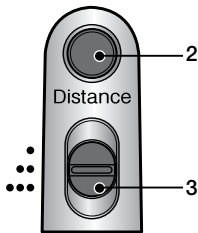

* The distance detection sensor forms a virtual straight barrier of the specified fence length.

Button operations

1. Mode lamp operations

- Fence (virtual wall) Mode: The red lamp flashes.
- Guard (virtual door) Mode: The green lamp flashes.
- Off: The lamp is turned off.

2. Setting the mode

- Whenever you press the Mode/Power button, Fence (virtual wall) mode → Guard (virtual door) mode → Power off is selected in this sequence.

3. Setting the Fence length

- Set the distance to restrict the access of robotic vacuum cleaner from the VIRTUAL GUARD using the distance control switch.

Switch Setting	Max Distance
• (Short)	About 1~2m
•• (Medium)	About 2~3m
••• (Long)	About 3~4m

* Set the switch according to the required fence length.

Forming a Fence (virtual wall)

VIRTUAL GUARD creates an invisible barrier that the robotic vacuum cleaner cannot cross. E.g. in front of pots, furniture, the front door, and so on.

1. Select Fence (virtual wall) mode using the Mode/Power button.

- The mode lamp flashes red.

2. Set the fence length using the distance control switch.

3. Install the VIRTUAL GUARD in front of the area you want to block access from the robotic vacuum cleaner.

- Install the VIRTUAL GUARD so that the distance detection sensor can form an invisible barrier that the robotic vacuum cleaner cannot cross.

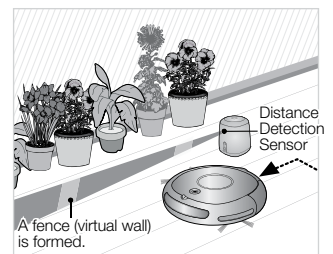

Operating the cleaner

Using Guard (virtual door) mode

The VIRTUAL GUARD forms an invisible door that the robotic vacuum cleaner cannot cross until current room is completely cleaned. The VIRTUAL GUARD opens the invisible door when cleaning the of room is complete.

1. Select Guard (virtual door) mode using the Mode/Power button.

- The mode lamp flashes green.

2. Set the fence length using the distance control switch.

3. Install the VIRTUAL GUARD at the entrance of the room to be cleaned.

- Install the VIRTUAL GUARD so that the distance detection sensor can form an invisible barrier that the robotic vacuum cleaner cannot cross.



- When not using the VIRTUAL GUARD, turn the power off. (When not using the robotic vacuum cleaner for long periods of time, separate the batteries to avoid discharging them.)
- If the Mode/Power button does not work, it indicates that the batteries have worn out. In this case, replace the batteries. (Specifications: Type D (LR20) alkaline batteries)
- You can additionally purchase a VIRTUAL GUARD from Samsung Electronics customer care Co., Ltd.

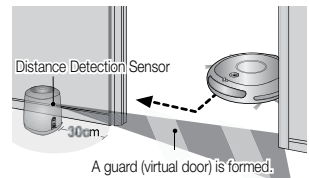
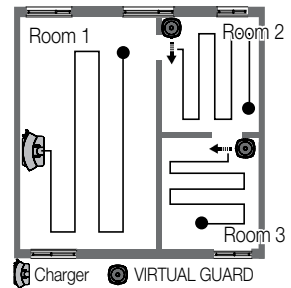

- * Since an invisible barrier is formed to prevent the robotic vacuum cleaner from running against the VIRTUAL GUARD, installing the VIRTUAL GUARD within 30 cm of the outside walls is recommended.



About the IrDA sensor.

- The infrared signal transmission may not be smooth in locations exposed to halogen lamps or in outdoor locations.
- Robotic vacuum cleaner uses 3 types of infrared devices and a device may not work in front of another device with a higher priority.
- When controlling the robotic vacuum cleaner with the remote control, the robotic vacuum cleaner may cross the virtual fence of the VIRTUAL GUARD or run against an obstacle, because the remote control signal has a higher priority than the VIRTUAL GUARD signal.
- When using the robotic vacuum cleaner in a small location or at a close distance, it may malfunction due to interference of the infrared signals.
- Install the VIRTUAL GUARD away from the charger as auto charging may be interrupted if the VIRTUAL GUARD is near the charger.
- If the fence length is set to a value longer than the required distance, the robotic vacuum cleaner may fail to clean properly.
 - Set the fence length to an appropriate value using the distance control switch.
- If more than one robotic vacuum is used simultaneously, they may malfunction due to interference of the infrared signals.
- Turn the VIRTUAL GUARD in another direction or set the fence length to an appropriate value if the distance detection sensor of the VIRTUAL GUARD faces the charger, as it may interrupt auto charging.

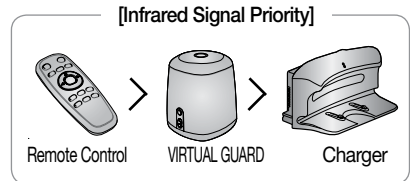

Operating the cleaner

USING THE ROBOTIC VACUUM CLEANER

STARTING/STOPPING CLEANING

You can run or stop all robotic vacuum functions.

- Each robotic vacuum function only runs when the Power Switch is turned on.
- When the robotic vacuum is operating, press the (Start/Stop) button to cancel the operation and select a function.

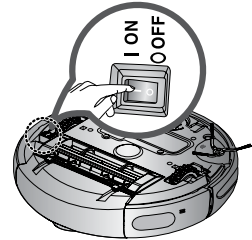

Turning the power on or off

Turning the power on

- Remote control: Press the **[Power]** button.
- Main unit: Press the (Start/Stop) button.
- The main unit buttons, battery level indicator and cleaning mode icons are turned on.

Turning the power off

- Remote control: Press the **[Power]** button.
- Main unit: Press and hold the (Start/Stop) button down for 3 seconds.
- All icons except for the battery level indicator are turned off.

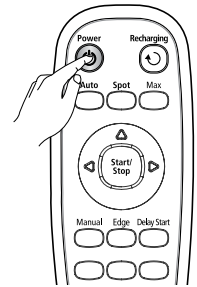

Using the remote control

Starting or stopping cleaning

Starting

- Remote control: Press the Auto, Spot, Max, Manual or Edge button.
- Main unit: Select Auto / Spot / Max / Manual / Edge mode by using the (Mode) button and then pressing the (Start/Stop) button.
- When cleaning begins, the robotic vacuum cleaner starts to move.
- * Pressing the (Start/Stop) button without selecting cleaning mode starts to perform the Auto mode cleaning.

Stopping

- To stop, press the (Start/Stop) remote control or main unit button.
- When cleaning is stopped, the robotic vacuum cleaner stops.

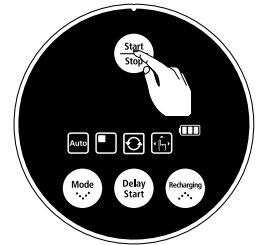

Using the main unit buttons

Operating the cleaner

USING THE ROBOTIC VACUUM CLEANER

RECHARGING

You can have the robotic vacuum cleaner return to the charger to charge the battery by using the Recharging button.

- When the robotic vacuum cleaner is operating, press the (Start/Stop) button to cancel the operation and press the Recharging button.

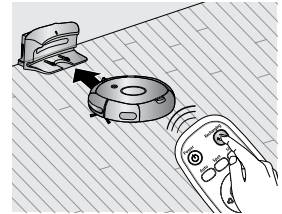

1. Press the Recharging button.

- The main unit icon (🌀) is turned on and the robotic vacuum cleaner will return to the charger.

2. To stop the robotic vacuum cleaner while it is returning to the charger, press the (Start/Stop) button.

3. To test the auto charge function, press the Recharging button when the robotic vacuum cleaner is less than 1.5 m from the charger.

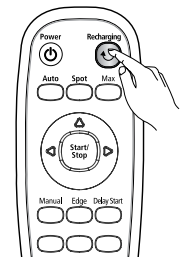

Using the remote control

Troubleshooting when the robotic vacuum cleaner does not return to the charger

- Check the installation of the charger
 - When the charger is in a location where the charger cannot guide the robotic vacuum cleaner to the charger.
 - When the charger is more than 5m away from robotic vacuum cleaner.
 - : It may require a longer time for the robotic vacuum cleaner to return to the charger.
- Manually charge the robotic vacuum cleaner in the following cases.
 - When the charger is installed in a corner.
 - When the battery is fully discharged.
 - When the robotic vacuum cleaner is trapped by an obstacle (furniture etc.)
 - When the robotic vacuum cleaner cannot pass over the doorsill to the location where the charger is installed. (The height of the doorsill should be about 1 cm or less).

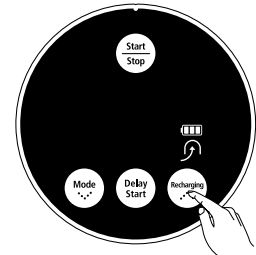

Using the main unit buttons

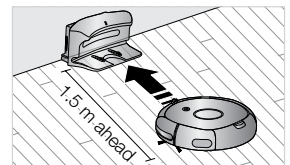

Operating the cleaner

USING THE ROBOTIC VACUUM CLEANER

AUTO CLEANING

The robotic vacuum cleaner will move by itself and automatically clean the house until cleaning is completed once.

- If cleaning begins when the robotic vacuum cleaner is docked with the charger station, the time to return to the charger is decreased since the robotic vacuum cleaner remembers its original position while moving.
- If the battery level becomes too low while cleaning, the robotic vacuum cleaner will automatically return to the charger station and resume cleaning after charging its battery. (Number of cleaning operations resumed: Once)

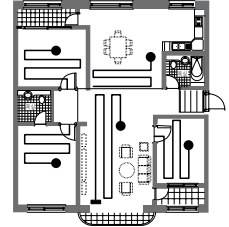

Main unit button	Remote control button	Configuration Sequence
		1 Set the mode.
		2 Cancel the mode.

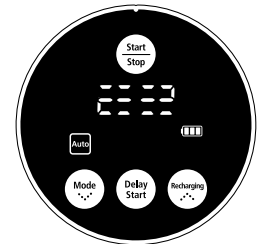

While cleaning



About the Resume Cleaning function

- If the robotic vacuum cleaner has evaluated that cleaning is complete, the resume cleaning function is not performed.
- If you move the robotic vacuum cleaner when it is being charged or press a button, the robotic vacuum cleaner judges cleaning to be complete and does not resume cleaning.

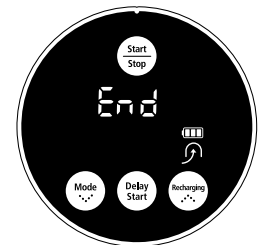

When cleaning is complete



Do not move the robotic vacuum cleaner when it is cleaning or press a button while it is cleaning. Otherwise, the robotic vacuum cleaner judges cleaning to be complete and starts cleaning again from the beginning.

Operating the cleaner

USING THE ROBOTIC VACUUM CLEANER

SPOT CLEANING

You can conveniently clean a specific area that has a lot of cookie crumbs, dust, and etc.

- Move the robotic vacuum cleaner to the location where you want to perform a spot clean.

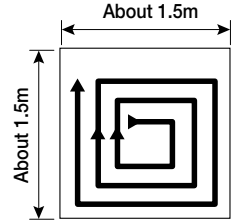

Main unit button	Remote control button	Configuration Sequence
		1 Set the mode.
		2 Cancel the mode.

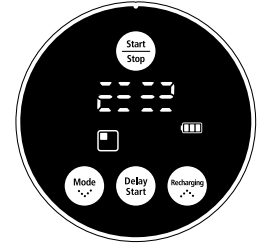

While cleaning

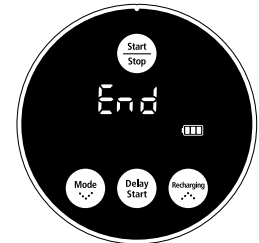

When cleaning is complete

- In Spot cleaning mode, the robotic vacuum cleaner cleans an area with a length of 1.5m and a width of 1.5m.
- When cleaning is completed, the robotic vacuum cleaner will display End, Stop, and Stand by.

NOTE When the robotic vacuum cleaner is docked with the charger station, spot cleaning is not supported.

Operating the cleaner

USING THE ROBOTIC VACUUM CLEANER

MAX CLEANING

The robotic vacuum cleaner automatically moves and cleans until the battery runs out and the battery level flashes only one level.

- If cleaning begins when the robotic vacuum cleaner is docked with the charger station, the time to return to the charger is decreased since the robotic vacuum cleaner remembers its original position while moving.
- If the battery level becomes low while cleaning, the robotic vacuum cleaner automatically returns to the charger station and resumes cleaning after charging the battery. (Number of resumed cleaning operations: Once)

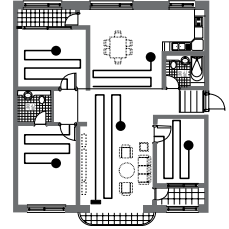

Main unit button	Remote control button	Configuration Sequence
		1 Set the mode.
		2 Cancel the mode.

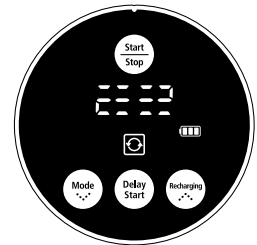

While cleaning



About the Resume Cleaning function

- If the robotic vacuum cleaner judges cleaning to be complete, resume cleaning is not performed.
- If you move the robotic vacuum cleaner while it is being charged or press a button, robotic vacuum cleaner judges cleaning to be complete (cleaning is not resumed).



Do not move the robotic vacuum cleaner while it is cleaning or press a button while cleaning. Otherwise, the robotic vacuum cleaner judges cleaning to be complete and starts cleaning again from the beginning.

Operating the cleaner

USING THE ROBOTIC VACUUM CLEANER

MANUAL CLEANING

You can move the robotic vacuum cleaner to clean a particular location directly by using the remote control.

- Move the robotic vacuum cleaner to the location where you want to perform manual cleaning.
- You can manually clean using the remote control only.

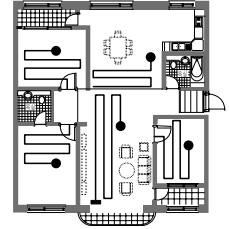

Main unit button	Remote control button	Configuration Sequence
		1 Set the mode.
		2 Cancel the mode.

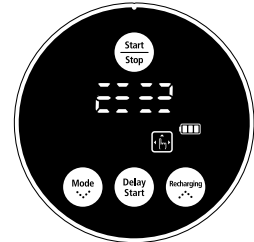

While cleaning

NOTE

- When the robotic vacuum cleaner is docked with the charger station, manual cleaning is not supported.

CAUTION

In manual cleaning mode, you can navigate to locations such as areas with a fence tape or areas with a risk of falling (stairs etc.) using the remote control.

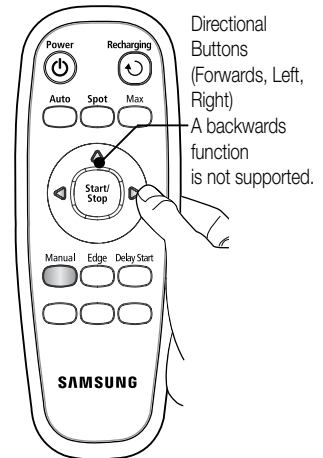

Operating the cleaner

USING THE ROBOTIC VACUUM CLEANER

EDGE CLEANING

When the Obstacle Sensor detects an obstacle during the cleaning, the Robotic vacuum Cleaner reduces its speed to minimize the bumping impact and the Bumper Sensor also helps it lower the bumping impact. It cleans the corners by reaching to them as close as possible. (This Robotic vacuum Cleaner is a touching type cleaner.)

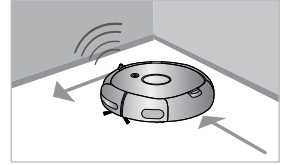

The robotic vacuum cleaner will move by itself and automatically clean the house until cleaning is completed once.

- If cleaning begins when the robotic vacuum cleaner is docked with the charger station, the time to return to the charger is decreased since the robotic vacuum cleaner remembers its original position while moving.
- If the battery level becomes too low while cleaning, the robotic vacuum cleaner will automatically return to the charger station and resume cleaning after charging its battery. (Number of cleaning operations resumed: Once)

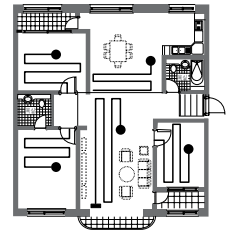

Main unit button	Remote control button	Configuration Sequence
		1 Set the mode.
		2 Cancel the mode.



While cleaning

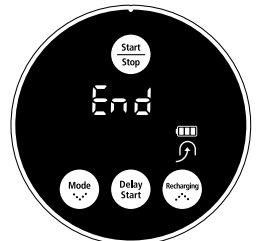

When cleaning is complete



About the Resume Cleaning function

- If the robotic vacuum cleaner has evaluated that cleaning is complete, the resume cleaning function is not performed.
- If you move the robotic vacuum cleaner when it is being charged or press a button, the robotic vacuum cleaner judges cleaning to be complete and does not resume cleaning.



Do not move the robotic vacuum cleaner when it is cleaning or press a button while it is cleaning. Otherwise, the robotic vacuum cleaner judges cleaning to be complete and starts cleaning again from the beginning.

Operating the cleaner

USING THE ROBOTIC VACUUM CLEANER

SCHEDULED CLEANING

You can schedule robotic vacuum cleaner to start cleaning from a particular time. (Time delay: Up to 23 hours)

- Scheduled cleaning is only performed when robotic vacuum cleaner is docked with the charger station.

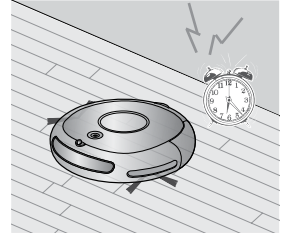

Main unit button	Remote control button	Configuration Sequence	(Example) To clean 5 hours Later from now
		1 Enter the Scheduled Cleaning mode.	 The icon is turned on.
		2 Whenever the button is pressed, the time is increased or decreased.	
		3 Finish the setting.	
		4 Cancel the setting.	 The icon is turned off.



When setting is complete, and you press the (Start/Stop) button instead of the Delay Start button, the scheduled cleaning time is canceled. After completing the setting, if you manually move the robotic vacuum cleaner from the charger station, the scheduled cleaning time is cancelled.

Maintain tools and filter

CLEANING THE ROBOTIC VACUUM CLEANER

PLEASE KEEP THE CLEANING AND MAINTENANCE METHODS IN MIND

- When the Power Switch is damaged, please contact the service agent so that it does not cause any accidents.
- Do not use any means or mechanical devices not installed by the manufacturer that could accelerate the deformation of the robotic vacuum cleaner.

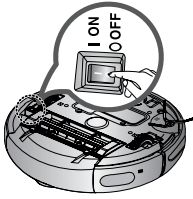

- Always turn off the power switch at the bottom of the main unit before cleaning the robotic vacuum. The robotic vacuum cleaner could operate suddenly and cause an injury.



CLEANING THE SENSOR WINDOW AND THE CAMERA

You must turn off the Power Switch at the bottom of the main unit before cleaning the robotic vacuum.

- Never spray water, thinner, benzene etc. directly onto the main unit of robotic vacuum cleaner.

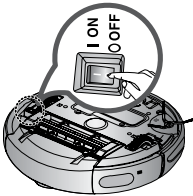

- Lightly wipe the sensor window or camera using a soft cloth.

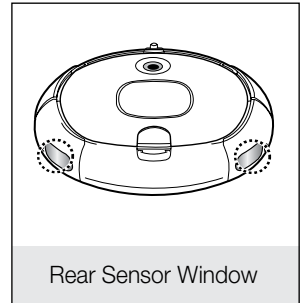
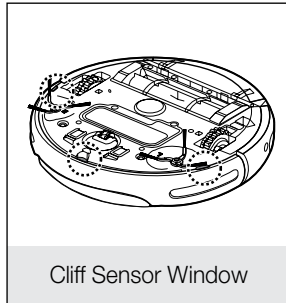
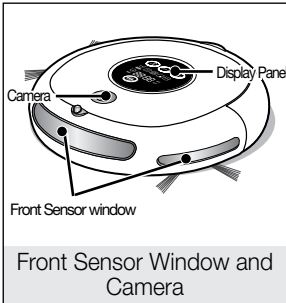
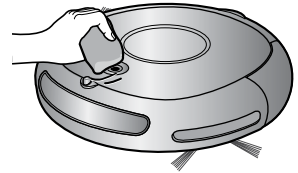

Maintain tools and filter

CLEANING THE ROBOTIC VACUUM CLEANER

CLEANING THE DUST BIN AND THE FILTER

First, empty the dust bin before cleaning it.

- When separating the dust bin, take care not to spill the dust out of the dust bin.
- Empty the dust bin in the following cases.
 1. When dust has accumulated inside the dust bin.
 2. When the suction power suddenly becomes weak.
 3. When the noise suddenly increases.

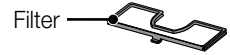

1. Press the Dust Bin Eject (PUSH) button and pull the dust bin to separate the dust bin.

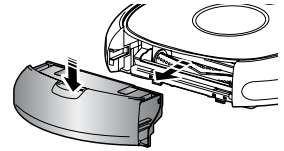

2. Separate the dust bin cover by pulling it in the direction of the arrow in the figure.

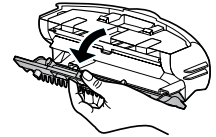

3. Separate the Filter from the dust bin by pulling it in the direction of the arrow in the figure.

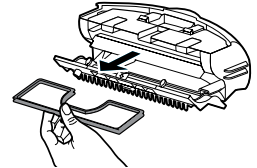

4. Wipe the dust from the Filter and the dust bin.

* You can wash them with water.

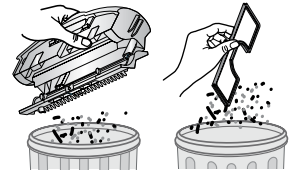

5. Install the Filter into the dust bin.

- Make sure that the grid pattern of the Filter is facing downwards. It cannot be installed in the wrong direction.

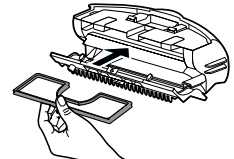

6. Close the dust bin cover and install it into the main unit.

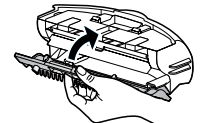

Maintain tools and filter

CLEANING THE ROBOTIC VACUUM CLEANER

CLEANING THE POWER BRUSH

You must turn off the Power Switch at the bottom of the main unit before cleaning the robotic vacuum.



- Because the dust in the dust bin may come out, separate the dust bin first before cleaning the power brush.

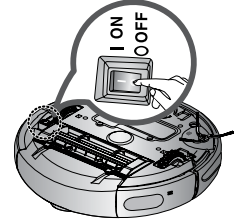

1. Separate the dust bin by pressing the Dust Bin Eject (PUSH) button.

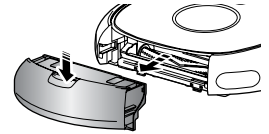

2. After checking whether there are any foreign substances, press the hook that is fixing the brush cover to separate it.

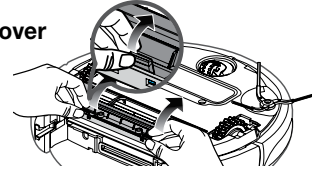

3. Lift the power brush up from the main unit.

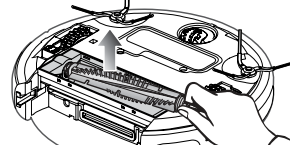

4. Remove any foreign substances such as long hairs or strings wrapped around the power brush using a cleaning brush or a vacuum cleaner.



5. When cleaning is complete, fix the Power Switch side of the power brush first and then fix the other side of the brush in the same way.

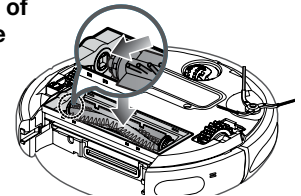

Maintain tools and filter

CLEANING THE ROBOTIC VACUUM CLEANER

6. After inserting the 3 tips at the top of the cover, push the other end in until it “clicks” into place.

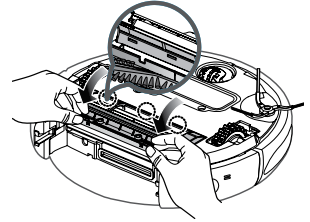

- To prevent the robotic vacuum cleaner from becoming clogged, be careful not to vacuum tooth picks or cotton swabs.
- When removing foreign substances becomes difficult, contact a customer care center.
- Because the power brush vacuums the dust on the floor, long strings or hair can become wrapped around the brush. Check and clean the power brush regularly.

Maintain tools and filter

CLEANING THE ROBOTIC VACUUM CLEANER

CLEANING THE EDGE-CLEANING SIDE ROTATING BRUSH

You must turn off the Power Switch at the bottom of the main unit before cleaning the robotic vacuum.

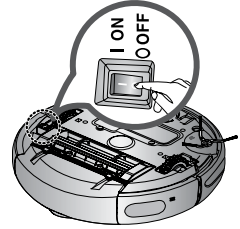

1. Check whether the side rotating brush is bent or whether there are any foreign substances stuck on the brush.

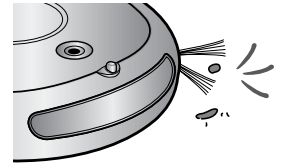

2. Wearing rubber gloves, wrap the side rotating brush with a cloth using hot water for about 10 seconds and wipe it on the cloth.

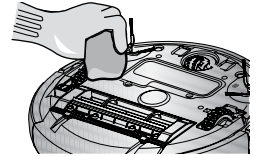

3. Turning the side rotating brush, repeat the procedures in Step 2.

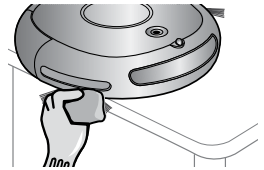

4. If hair or string is wrapped between the main unit and the side rotating brush, undo the screw of the side rotating brush using a (+) driver to remove it. When reassembling the brush, check the "L" mark on the edge-cleaning side rotating brush and the "L" mark on the main unit and then reassemble the side rotating brush. (Letter "R" is carved at the right side rotating brush.)

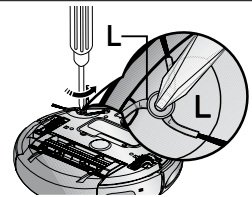

Because the side rotating brush easily attracts hair and other foreign substances, make sure to clean it frequently.

Excessive foreign substances on the side rotating brush can damage the brush.

Maintain tools and filter

CLEANING THE ROBOTIC VACUUM CLEANER

CLEANING THE DRIVING WHEEL

You must turn off the Power Switch at the bottom of the main unit before cleaning the robotic.

- If the robotic vacuum cleaner suddenly starts to zigzag, there may be foreign substances stuck on the driving wheel.

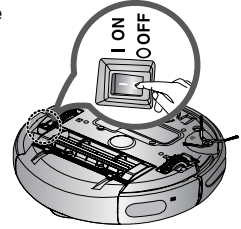

- 1. When cleaning the driving wheel, place a soft cloth on the floor and flip the main unit, placing it down carefully.**

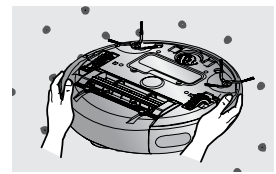

- 2. Check for foreign substances and remove them using a stick or a pair of blunt nippers if necessary.**

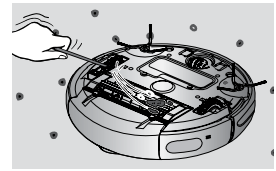

Troubleshooting

CHECKLIST BEFORE SVC CALLS

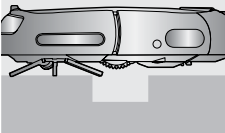
SYMPTOM	CHECKLIST	MEASURE TO TAKE
Robotic vacuum cleaner does not operate at all before cleaning.	<ul style="list-style-type: none"> Is the dust bin assembled? Is the Power Switch turned on? Is cleaning mode (Auto) in the display panel turned on? Is the battery level flashing only one level and is 'LO' displayed in the display panel? Robotic vacuum cleaner will not operate when the battery in the remote control is depleted. 	<ul style="list-style-type: none"> Install the dust bin. Turn on the Power Switch. Press the (Start/Stop) button. (To turn it off, press and hold the (Start/Stop) button down for 3 seconds or longer.) Lift up the robotic vacuum cleaner, and manually dock the robotic vacuum onto the charger to charge it. Replace the batteries in the remote control. (AAA type)
Robotic vacuum cleaner stopped operating while cleaning. 	<ul style="list-style-type: none"> Is the battery level flashing only one level and is 'LO' displayed in the display panel? Has the robotic vacuum cleaner become hooked on wires on the floor? Is the robotic vacuum cleaner stuck to the floor where there is a height difference? <ul style="list-style-type: none"> The driving wheel is lifted. Is there a thin towel (cloth) wrapped around the driving wheel? Is the robotic vacuum cleaner stuck on the doorsill? 	<ul style="list-style-type: none"> Lift up the robotic vacuum cleaner, manually dock the robotic onto the charger to charge it. Turn off the Power Switch and remove the wires. Turn off the Power Switch and move the cleaning robotic vacuum to another place to clean. Turn off the Power Switch and remove the thin towel. Turn off the Power Switch and move the robotic vacuum cleaner to another place to clean.
The suction power is weak while cleaning.	<ul style="list-style-type: none"> Check whether the dust bin is full of dust. Check whether the suction inlet is clogged by foreign substances. Check whether the Filter is clogged. 	<ul style="list-style-type: none"> Stop the robotic vacuum cleaner and empty the dust bin. Turn off the Power Switch and remove the foreign substances on the suction inlet. Clean the Filter well.

Troubleshooting

CHECKLIST BEFORE SVC CALLS

SYMPTOM	CHECKLIST	MEASURE TO TAKE
Robotic vacuum cleaner cannot find the charger.	<ul style="list-style-type: none"> • Check whether the power plug of the charger is plugged correctly into the outlet. • If there are any obstacles within a range of about 1m in front of the charger and about 0.5m range to the left and right of the charger, you should remove the obstacles. • If there are any foreign substances on the charge pin, wipe them off with a dry towel. • Is the VIRTUAL GUARD installed near the charger? • Is the distance detection sensor of the VIRTUAL GUARD facing the charger? 	<ul style="list-style-type: none"> • Move the VIRTUAL GUARD to another place so that the robotic vacuum cleaner can charge automatically. • Change the direction of the VIRTUAL GUARD or set the distance to an appropriate value.
Robotic vacuum cleaner passes through the VIRTUAL GUARD.	<ul style="list-style-type: none"> • Are the batteries of the VIRTUAL GUARD worn out? • Is the VIRTUAL GUARD set to Guard (virtual door) mode? • Is the Mode lamp turned off? 	<ul style="list-style-type: none"> • Replace the batteries. (2 type D (LR20) alkaline batteries) • Set the VIRTUAL GUARD to Fence (virtual wall) mode. • Check if the VIRTUAL GUARD is turned off and then set the VIRTUAL GUARD to a desired mode.
The battery usage time of the VIRTUAL GUARD is too short.	<ul style="list-style-type: none"> • Are you using manganese drycell batteries? 	<ul style="list-style-type: none"> • Replace the batteries with new alkaline batteries. (2 type D (LR20) alkaline batteries)

Troubleshooting

TROUBLESHOOTING FOR ERROR CODES

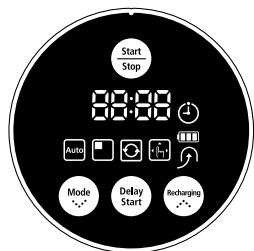

ERROR CODE	CAUSE	SOLUTION
[00	<ul style="list-style-type: none"> Robotic vacuum cleaner is caught, stuck or trapped while navigating. 	<ul style="list-style-type: none"> Turn off the Power Switch at the bottom and move the robotic vacuum cleaner to a different location.
[01	<ul style="list-style-type: none"> A foreign substance (string, paper, toy etc.) is caught in the power brush. 	<ul style="list-style-type: none"> Turn off the Power Switch at the bottom and remove the foreign substance from the power brush.
[02	<ul style="list-style-type: none"> A foreign substance (string, paper, toy etc.) is caught in the left driving wheel. 	<ul style="list-style-type: none"> Turn off the Power Switch at the bottom and remove the foreign substance from the left driving wheel.
[03	<ul style="list-style-type: none"> A foreign substance (string, paper, toy etc.) is caught in the right driving wheel. 	<ul style="list-style-type: none"> Turn off the Power Switch at the bottom and remove the foreign substance from the right driving wheel.
[05	<ul style="list-style-type: none"> Check bumper sensor. 	<ul style="list-style-type: none"> Slightly pull the stuck bumper outward.
[06	<ul style="list-style-type: none"> A foreign substance (dust, stain etc.) is on the Obstacle sensor window. 	<ul style="list-style-type: none"> Turn off the Power Switch at the bottom and wipe the foreign substance from the front and rear sensor windows using a soft cloth.
[07	<ul style="list-style-type: none"> A foreign substance (Dust, stain etc.) is on the Cliff sensor window. 	<ul style="list-style-type: none"> Turn off the Power Switch at the bottom and wipe the foreign substance on the cliff sensor window with a soft cloth.
[08	<ul style="list-style-type: none"> Dust bin not inserted. 	<ul style="list-style-type: none"> Insert the dust bin until you hear a "Click" sound.
[09	<ul style="list-style-type: none"> A foreign substance (String, cloth etc.) is caught on the edge-cleaning side rotating brush. 	<ul style="list-style-type: none"> Turn off the Power Switch at the bottom and wipe the foreign substance from the edge-cleaning side rotating brush.

* If you press the Start/Stop button or turn off the Power Switch, the error code is cleared.

Product specification

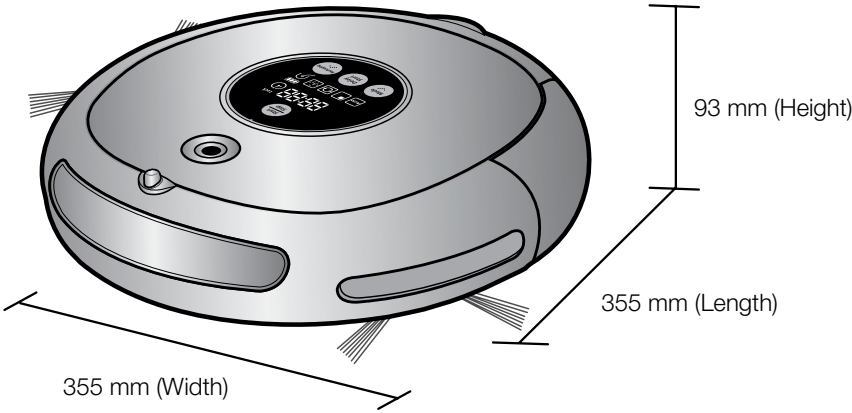

Main Body

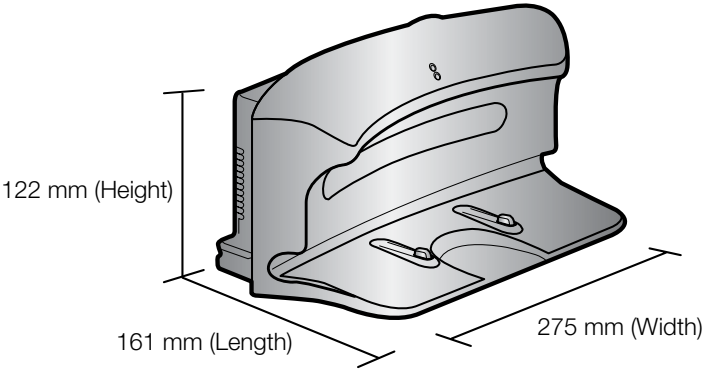

Charger(Station)

Product specification

CLASSIFICATION	ITEM	DETAIL
Mechanical Specifications	Diameter	355mm
	Height	93mm
	Weight	4.0kg
Electrical Specifications	Power voltage	AC 220-240V~, 50-60Hz
	Charge power consumption	50 W
	Main unit power consumption	40 W
	Battery specifications	14.4V / 2,000 mA
Cleaning Specifications	Dust bin capacity	About 0.6 ℓ
	Charging type	Auto Charging/Manual Charging
	Cleaning mode	Auto, Spot, Max, Manual, Edge, Scheduled Cleaning
	Charging time	About 120 minutes
	Cleaning time (on the basis of hard floor)	About 90 minutes
Cleaning method		Ceiling shape recognition
Main unit button type		Button type

This Vacuum cleaner is approved the following.

Electromagnetic Compatibility Directive : 2004/108/EEC

Low Voltage Directive : 2006/95/EC

memo

memo

memo



If you have any connects or questions, regarding a Samsung Products.
Contact the SAMSUNG Customer Care Center.

Country	Customer Care Center ☎	Web Site
U.K	0845 SAMSUNG (7267864)	www. samsung.com
SOUTH AFRICA	0860-SAMSUNG (726-7864)	www. samsung.com